

secabo

secabo

OPERATING INSTRUCTIONS

for the Sheet Vinyl Cutter

Secabo SC30

Congratulations on the purchase of your Secabo Sheet Vinyl Cutter!

Please carefully read the operating manual to easily integrate your unit into your production environment.

Any type of reproduction of this operating manual requires the written permission of Secabo GmbH. Changes and errors in the technical data and the product characteristics are reserved.

The Secabo GmbH is not liable for any direct or indirect damages occurring as a result of the use of this product.

Version 1.0 (30.04.2018)









Safety measures

Please read the information and safety measures carefully prior to initial operation of the unit!

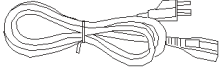
- Do not place any magnetic objects in the vicinity of the cutting head; otherwise uniform contact pressure is not ensured.
- Do not remove the connection cable to the computer while plotting is in progress.
- Relieve the pressure on the pressure rollers when not in use by moving the pressure lever up.
- Do not reach into the unit when it is connected to electricity supply.
- Never open the casing and do not make any modifications to the unit yourself.
- Ensure that neither liquids nor metal objects are put inside the Sheet Cutter.
- Ensure that the wall socket used is grounded and protected with a ground fault switch.
- Ensure that the connected voltage (230V) does not deviate by more than $\pm 10\%$. Otherwise install a voltage stabilizer.
- Pull the power plug if the unit will not be in use for a longer period of time.
- Never reach into the unit in the vicinity of the blade holder during the cutting operation!
- Discontinue any printing jobs in progress before readjusting the blade holder!
- Always ensure that the Sheet Cutter is out of reach of children during operation and never leave the unit or individual parts of it switched on without supervision.
- Do not touch the tip of the sliding blade to avoid injury.
- Always place the unit on a stable base to prevent it from falling down.
- Do not operate the unit during thunderstorms; it can be damaged or destroyed by lightning.

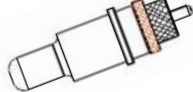
Items included

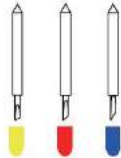
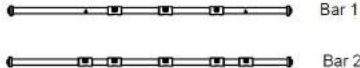
Before starting work, please check whether the following items are all present:

Article	Quantity	
SC30 Sheet Cutter	1	
Power cable	1	
USB connection cable	1	
Blade holder	1	
Pen holder	1	
Drag knife	1x 30° (yellow cap) 1x 45° (red cap) 1x 60° (blue cap)	
Front bars	1x Bar 1 for DIN A4 size 1x Bar 2 for DINA3 or A3 plus	
Certificate of DrawCut PRO (Sheet Cutter) license	1	
Fuse 5A	1	

Device parts and their function

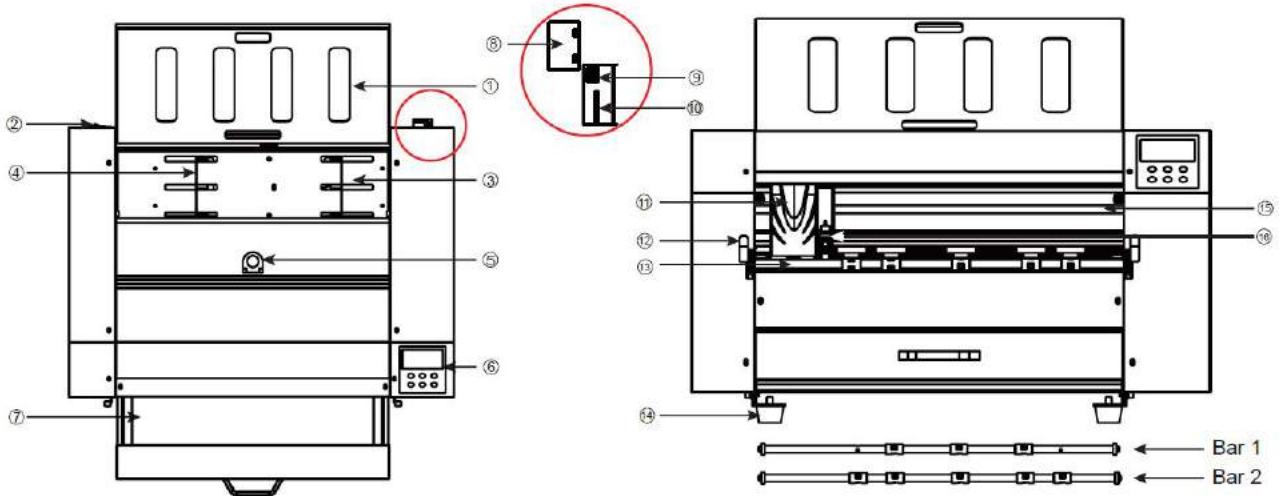

1. Support paper parts
2. Power switch
3. Paper tray
4. Paper guidance
5. Cover handle
6. Control panel with operation buttons
7. Drawer
8. Cable Clamp for USB cable
9. USB interface connector
10. SD-card interface connector (without assignment)
11. Carriage
12. The switch of bar
13. Front bar
14. Rubber Feet
15. Carriage Belt
16. Blade Holder

Control panel

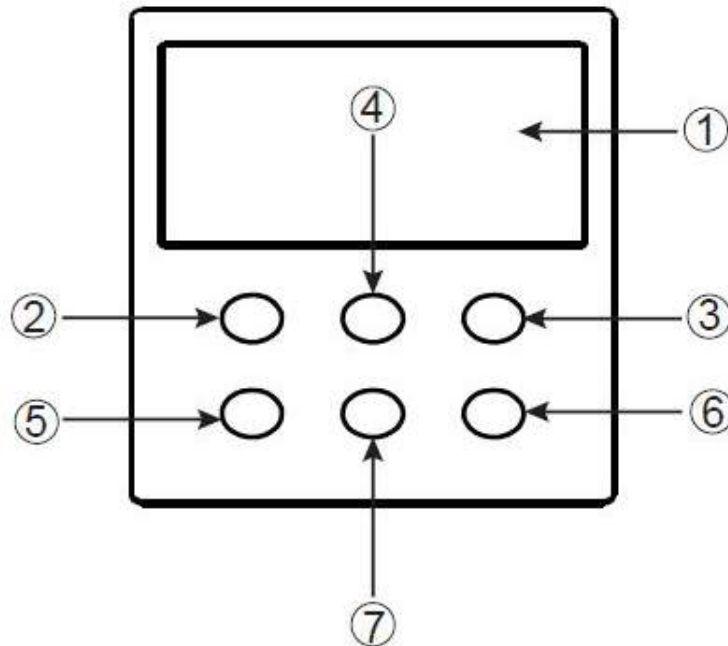

1. Touch Screen

a. Set

- i. **Speed:** Display speed parameters, (the data refers to the fastest cutting straight line)
- ii. **Force:** Display force parameters.
- iii. **XP:** The scaling of the X direction (feeding direction), generally do not need to change
- iv. **YP:** The scaling of the Y direction (Carriage direction), generally do not need to change.
- v. **Fan Setting:** Suction fan switch and settings, Prt Sensor Val: This is useless for user.
- vi. **LED:** LED lights above the carriage, please keep it open when working-Enable
- vii. **VER:** The version for firmware.

b. Test

- i. **Force:** Directly adjust the pressure.
- ii. **Sensor status:** it will show red if the sensor has a cover and the opposite shows black.
- iii. **S1:** The position in front of the front bar, checking after the work, the paper is remove the plotter or not.
- iv. **S2:** The position in back of the pinch roller, control the feeding.
- v. **S3:** The position in paper tray, checking if there is any paper in the tray and control the feeding.



- vi. **Load:** Take a piece of paper on the S1 sensor, press load, the machine will automatically feed the paper and the carriage moved to the paper, ready to test.
 - vii. **Scale Test:** The carriage will cut one squares(100mm×100mm)
 - viii. **Force Test:** The carriage will cut one squares and triangles in order to test the force.
 - ix. **Eject:** Exit the paper directly.
 - x. **Return:** Save the force setting and back the main interface.
- c. **Offline:** you can move the carriage and feeding direction manually and set the origin
2. **Key without assignment**
 3. **Back---Return to the last interface**
 4. **Direction Key----Up key**
 5. **Direction Key----Left key**
 6. **Direction Key----Right key**
 7. **Direction Key----Down key**

Initial operation of machine and software

Caution! Please note that the smooth installation and complete configuration requires DrawCut PRO to be installed first.

Installation DrawCut PRO

Minimum Computer Configuration

- IBM Compatible 1Ghz CPU
- 2Gb of available Hard Disk Drive space
- 2Gb of RAM

- SVGA color monitor set to a min 1024*768
- 256Mb SVGA Video/Graphics card
- 2 Button Mouse
- Microsoft Windows Xp (Service Pack 3)
-

Recommended Computer Configuration

- Intel Quad-Core+
- 100Gb+ of available Hard Disk space
- 16Gb+ of RAM
- DVD Read Write Drive
- Dual 24"+ Color monitors(1900 Pixels+ Wide)
- 4.0Gb+ Video/Graphics card
- 2 Button Scrolling Wheel Mouse
- Sound & Speakers
- Microsoft Windows 7, 8 or 10 pro (64 bit)



Your Secabo Sheet Cutter is delivered with the cutting software DrawCut PRO. This software must be activated over the Internet. You do not necessarily need internet access on the computer, on which DrawCut will be installed. The activation can also be done on another computer.

In order to control your Sheet Cutter via your computer, install the software as described below:

- Disable the Windows Firewall and your anti-virus software for the time of installation.
- Download the current version of DrawCut PRO (Sheet Cutter) at http://fcws6.com/downloads/drawcut/Install_DrawCutPro_DL_MV_BCA.exe and follow the installation wizard.
- Find your 26-digit DrawCut serial number on the printout that was delivered with your Sheet Cutter. Enter it when you are prompted to do so.
- Choose the language
- Select your model
- Now you can use DrawCut PRO (Sheetcutter).

Installation of your Secabo Sheet Cutter in DrawCut

- First, make sure that your PC is connected to the Internet.
- Connect the Sheet Cutter to your computer using the supplied USB cable.
- Switch on the device.
- Your Secabo Sheet Cutter will now be detected. Windows will search for the appropriate drivers and automatically install them. This can take some time. After that, the device is ready for operation.
- Start DrawCut.
- Run the Spooler in Drawcut Pro

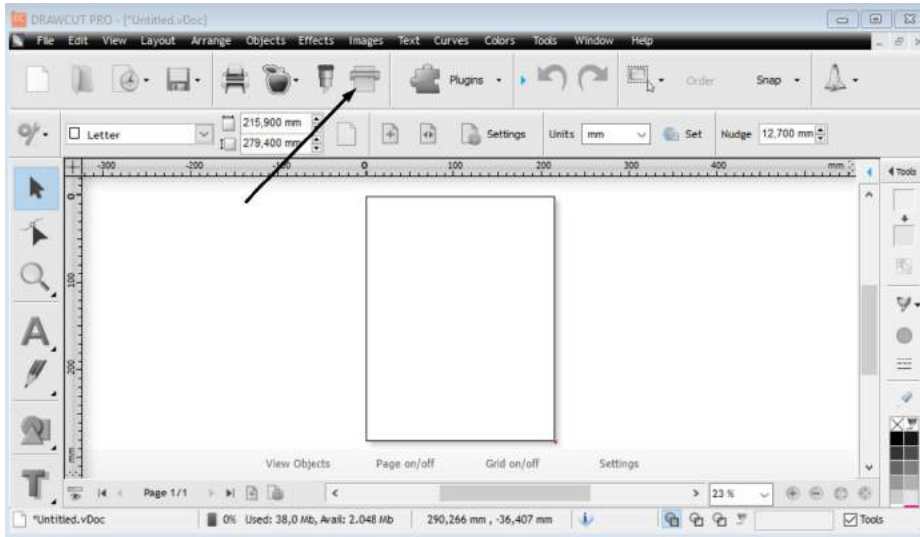

- Click on Lapos Q Controller

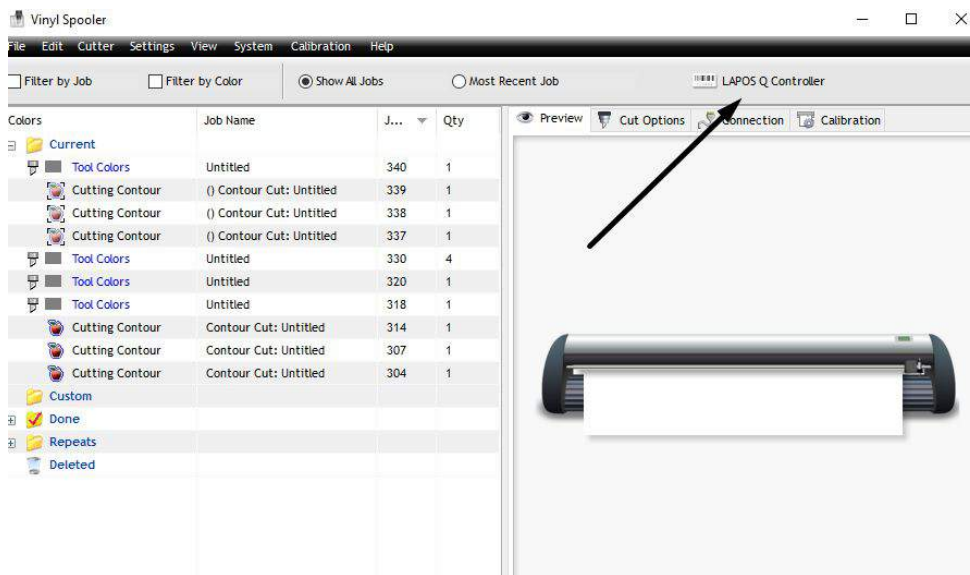

- The Lapos Q module should now be running.

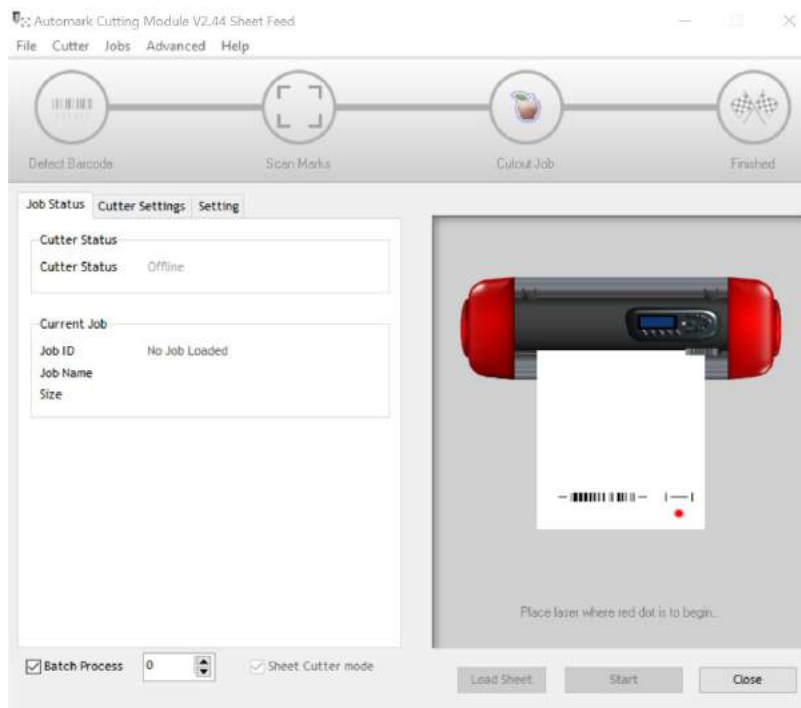

- Confirming that the machine has the correct firmware version
 - After you have first installed the program you will need to run a quick test to ensure that the machine has been shipped with necessary firmware version needed to scan barcodes correctly.
 - 1. Open the Barcode controller module.
 - 2. Ensure that the machine is connected to the computer, plugged in and turned on.
 - 3. From the “Cutter” menu, click on “Check Cutter Compatibility”

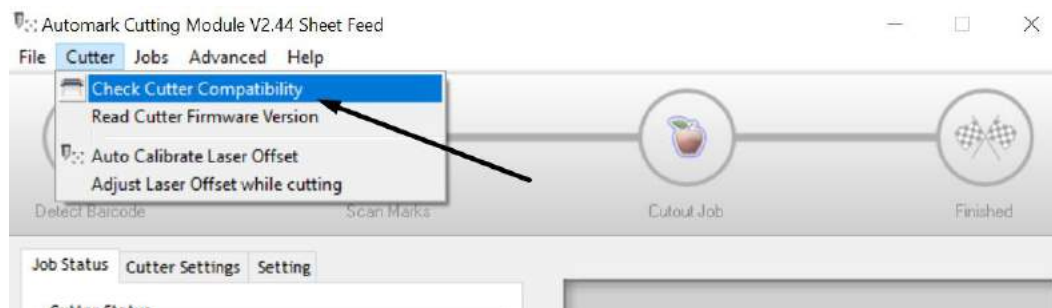

The software will then inform you if the machine has the required firmware and is ready to be used with the software.

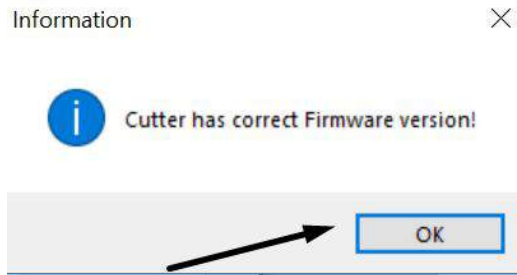

Initial Calibration

After you have installed the program you will need to perform an initial calibration of the Lapos sensor. This calibration is required and has to be done only once.

Instructions:

- Remove the blade from the cutter, and load the pen tool. Load a sheet of plain A4 paper and test if the pen is drawing correctly. Adjust the force if required until you are able to get a sharp continuous pen line.
- Load a blank sheet of paper into the machine and position the pen in the middle of the sheet of paper and set the base point (origin) to 0,0.
- Run the Barcode controller, and from the "Cutter" menu, click on "Auto Calibrate Laser Offset"

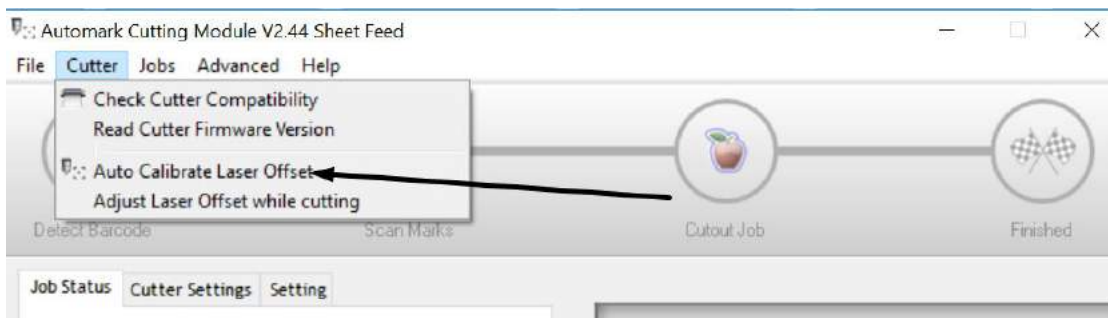

- The machine will move over the area it is about to mark with the pen. If the cutter does not move the pen off the edge of the paper, click ok to begin the automatic calibration process.
- Once completed, the software will now be calibrated, ready to use.
Note: If the calibration process fails, ensure that the pen is making clear, sharp lines on the paper.

Cutting the Sample test print

- After calibrating the laser offset, you are ready to perform a cutting test using a pre-designed sample.
- Open the barcode controller.
- From the “Jobs” menu, click on “Sample File” to open the pre-designed sample file.

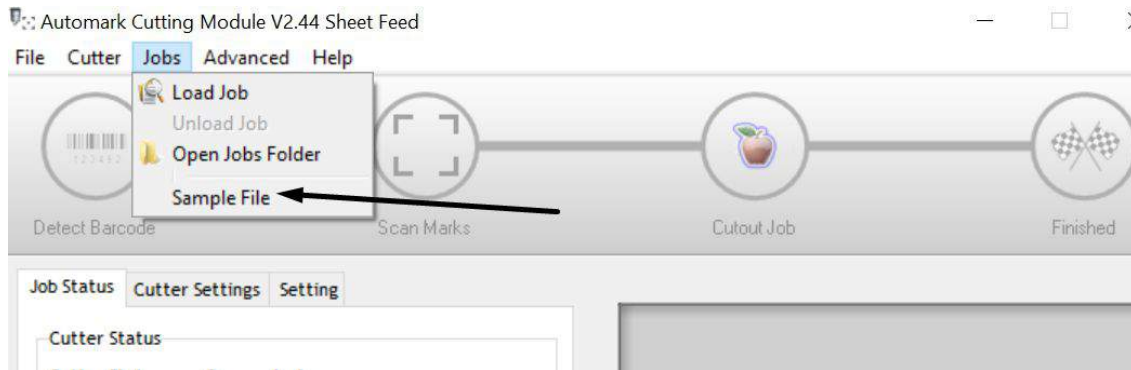

- Print this PDF file at 100% size. This is a very important detail when using the sheet cutter. All artwork needs to be printed at the actual size, and not scaled to fit the paper. The sample test print contains a box that should measure 180mm x 180mm, which you can check after printing to confirm that the artwork is printing at the correct size.

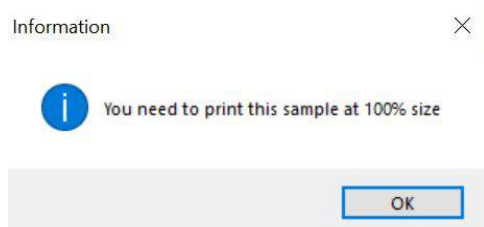

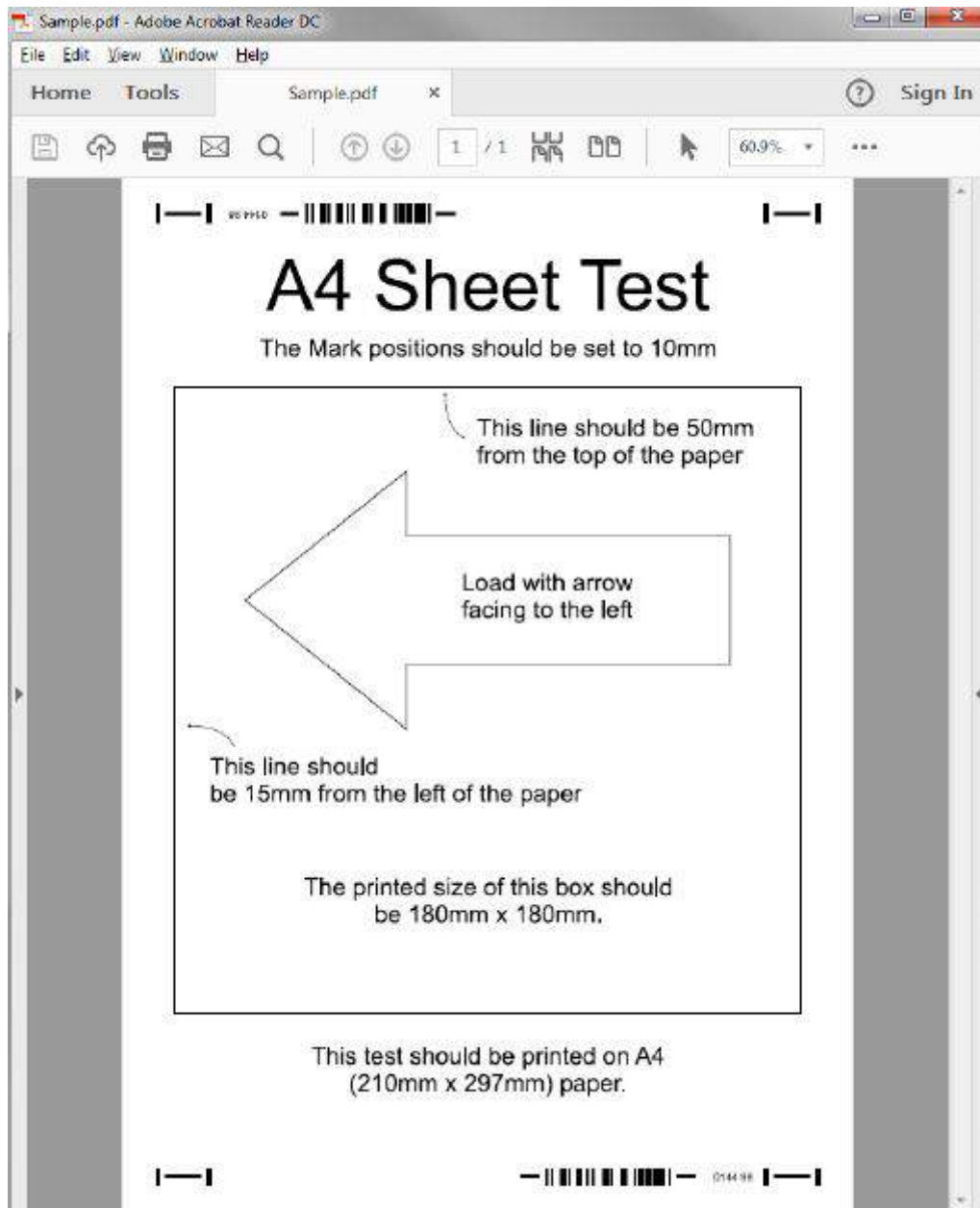

- Load the test print(s) into the sheet cutter.
- In the Barcode controller, set the Mark positions to match the position of the marks in this job.

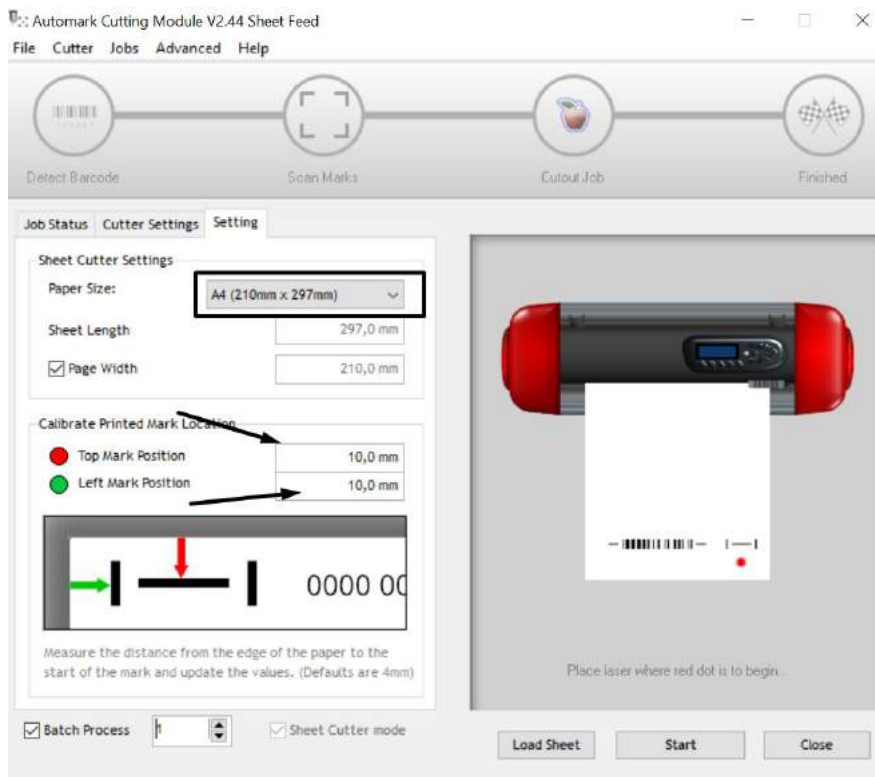

Note:

When designing the artwork, you are able to choose how far the marks are placed from the edge of the paper. You should try to use the same value for all jobs, so you do not have to keep changing this value. If you do not have the mark positions set correctly, the cutter will try to look for the marks in the wrong place, and be unable to find them.

- Click “Start” to begin scanning and cutting the sheet.

Note:

If you are using plain paper, remember to use the pen tool, and not the blade tool!

Creating your first design

After you have practiced with sample print, you are now ready to create your own artwork. The instructions below show you the main steps required to build, print and send the artwork to the machine.

- Ensure that the page size for your artwork is set to either A4 or A3 (or for A3+, 320mmx480mm)

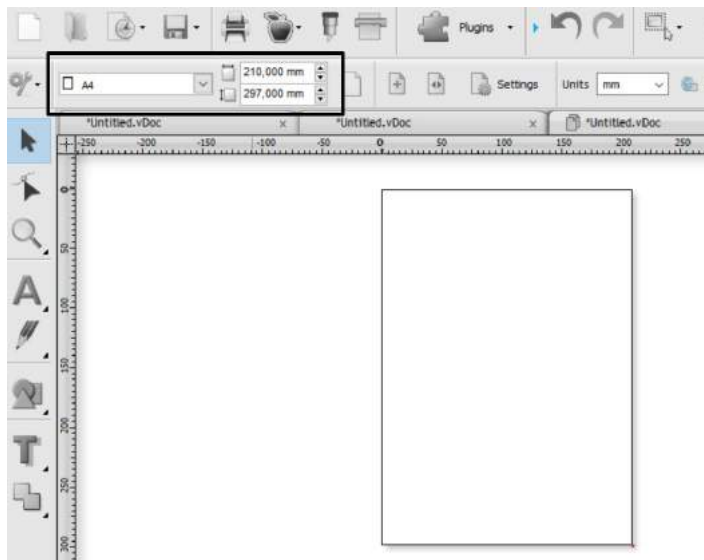

- Click on the “Contour Cut Wizard” so you can add the scanning marks and barcode.



- Click on “Page Marks” to apply page marks and confirm that with OK.

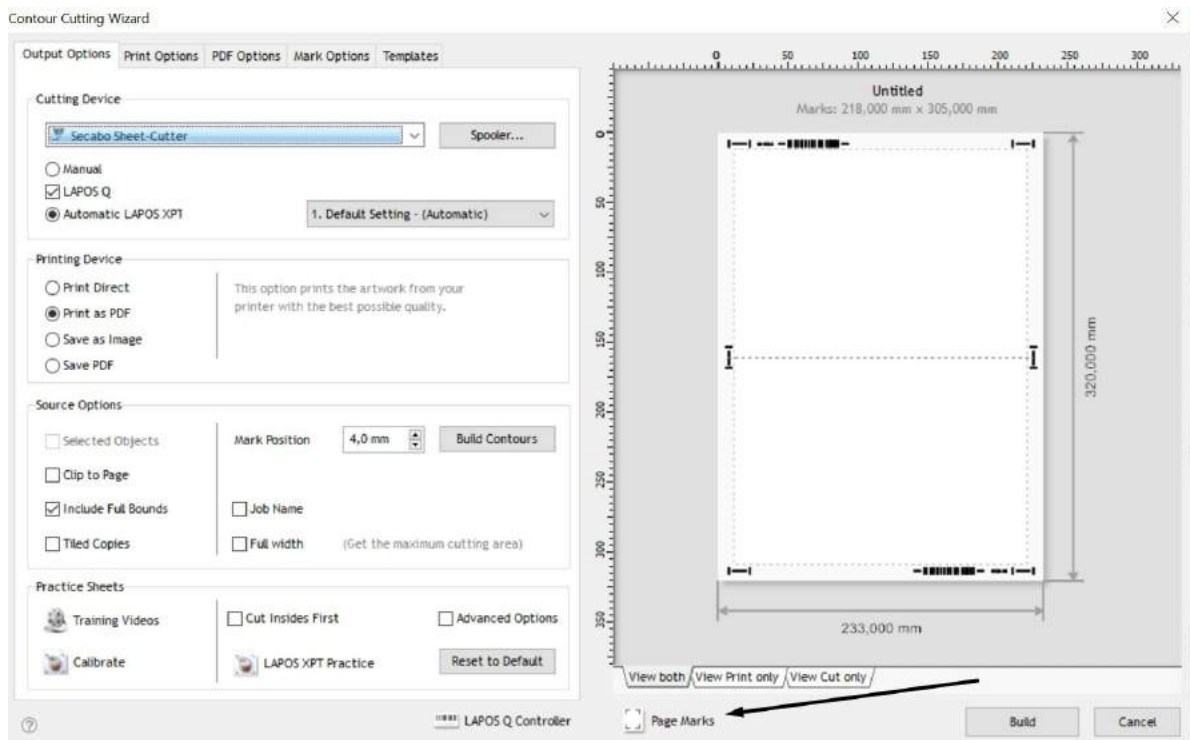

- Check if the Page Mark Margins are correct in the Print Options.

Note:

You should ensure that the Top margin and the Bottom margin are set to the same value, so you can load the sheets upside down as well as the normal way.

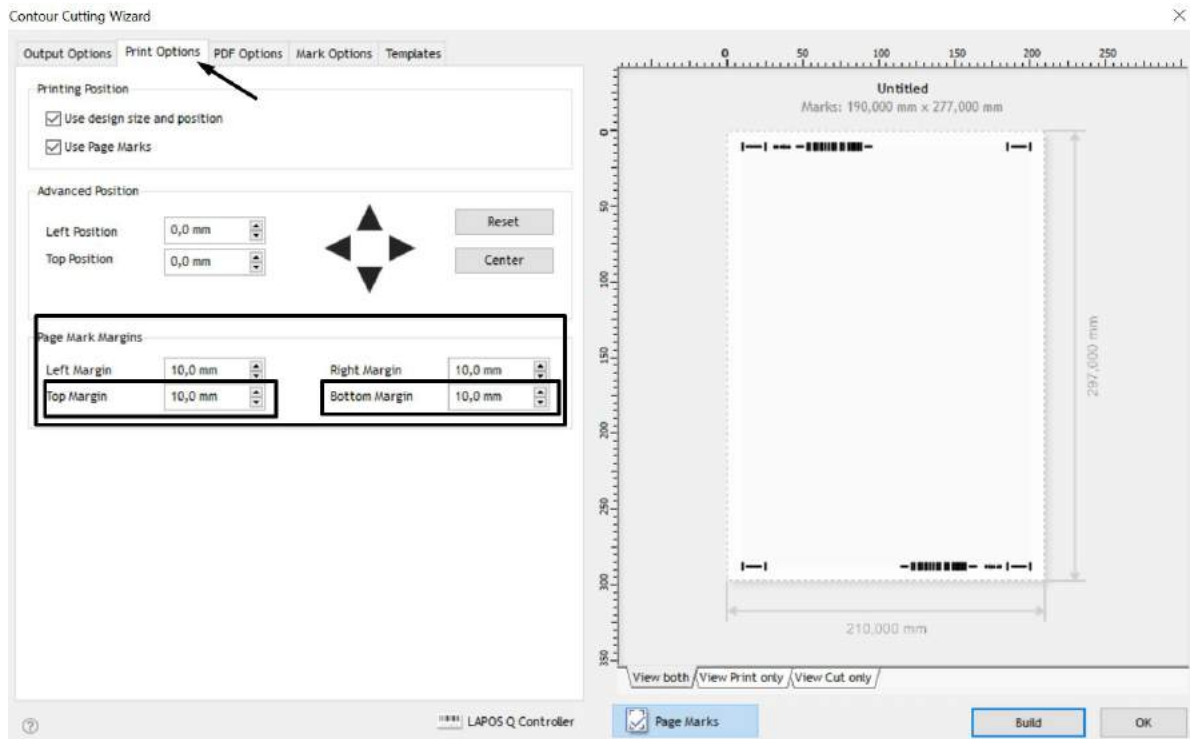

- Close the Contour Cutting Wizard with OK to return to the designing window.
- Load your artwork that you want to cut (using the “File” -> “Import” menu)

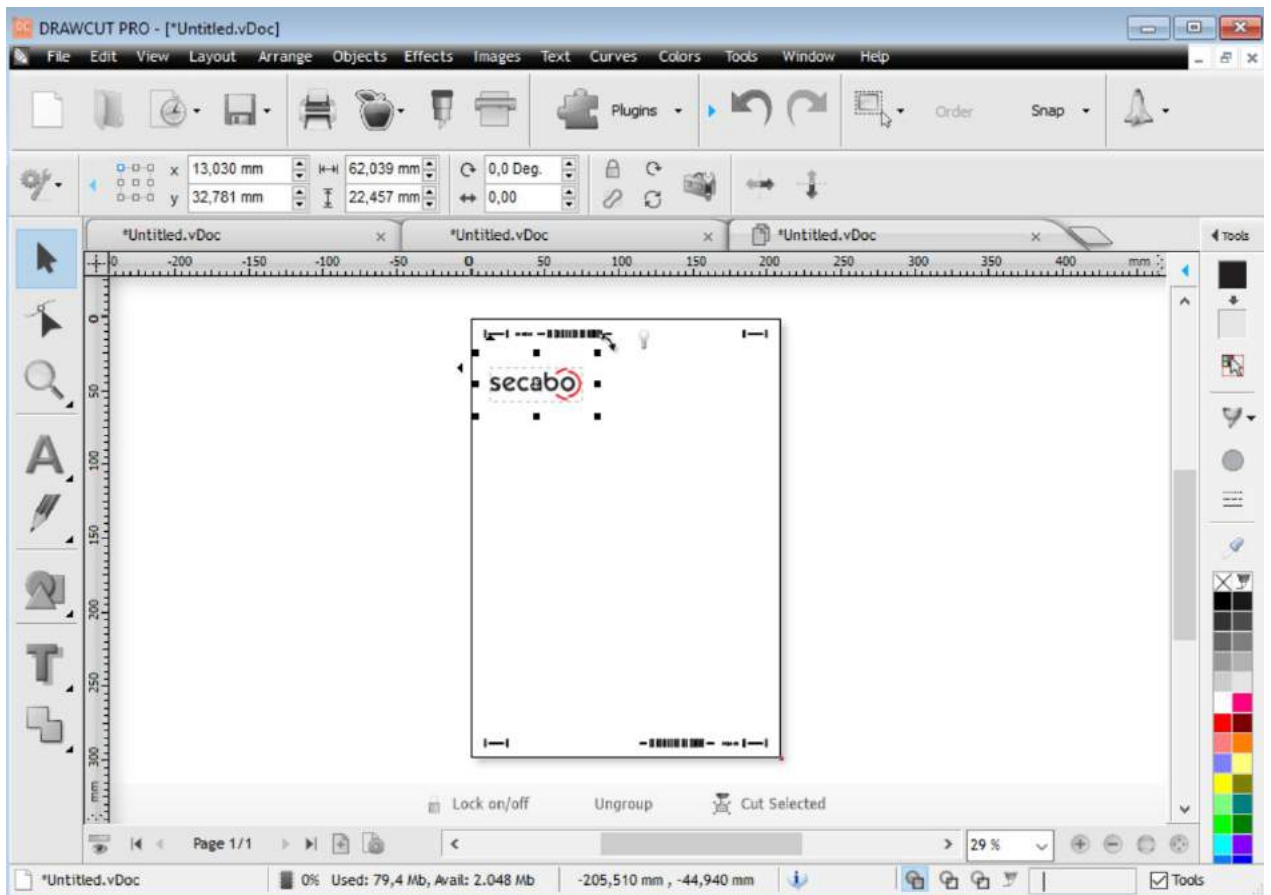

- Click on “Create Cut Contour” to build the cutting contour

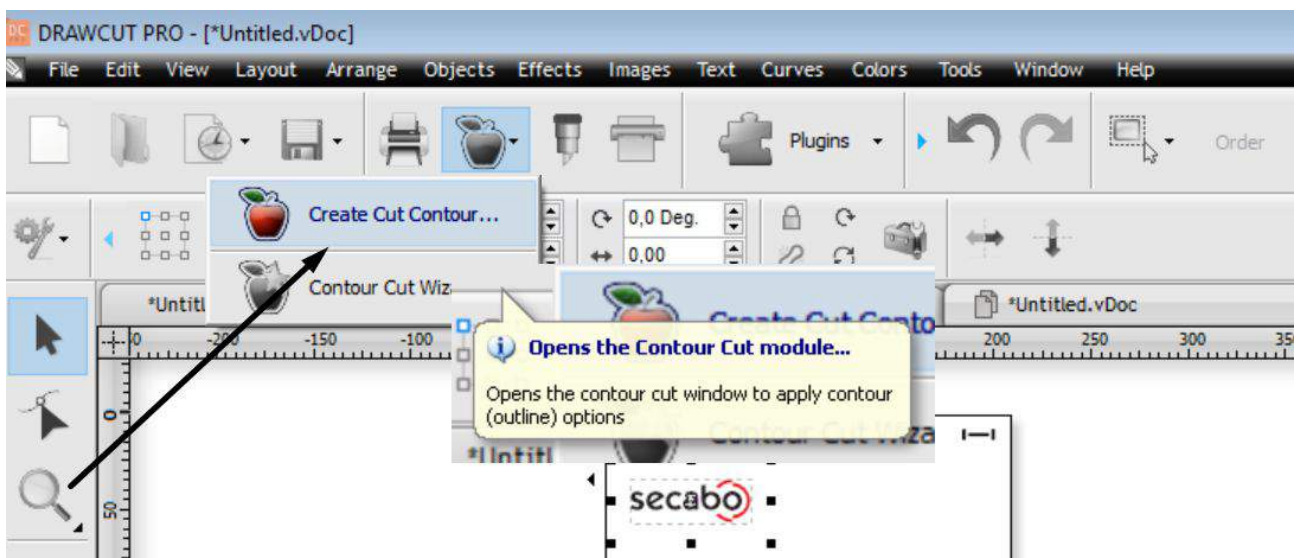

- Generate the cutting contour then click “Accept”

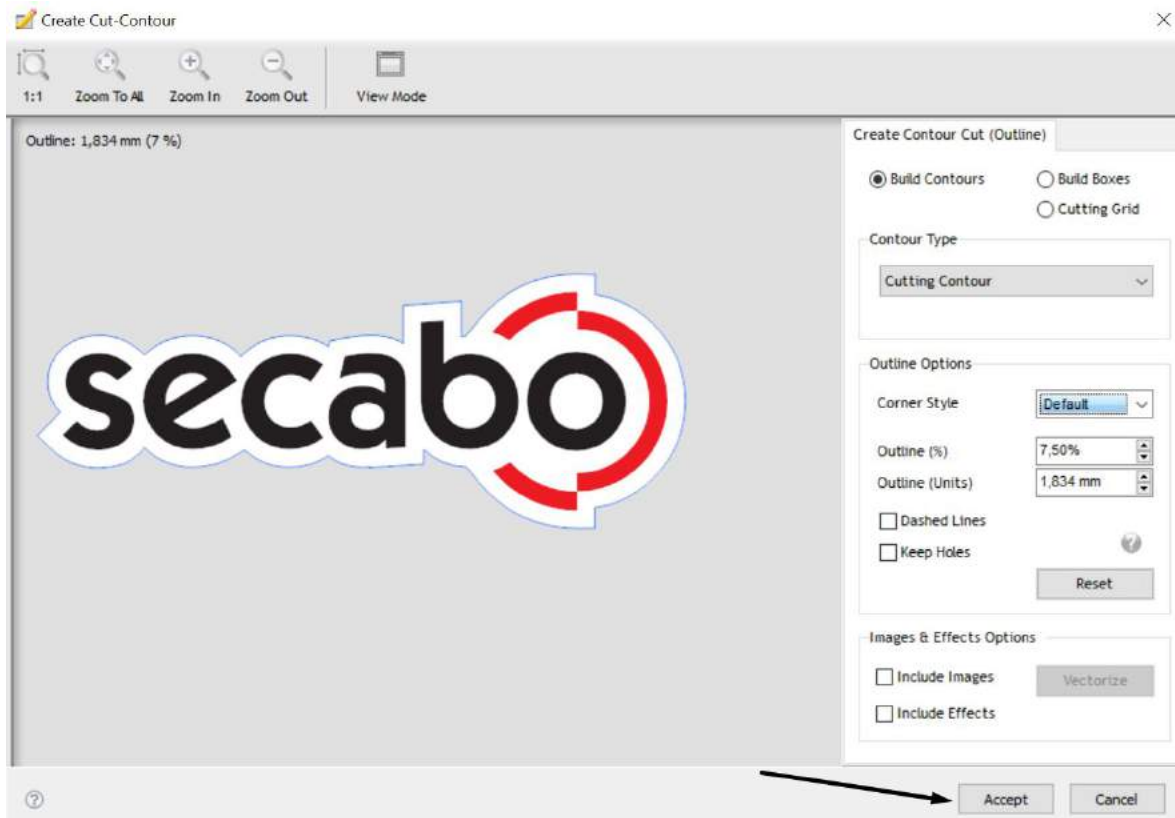

- Duplicate the logo, using either the “Tile Array” tool, or manually making copies using the “+” key on the number pad.

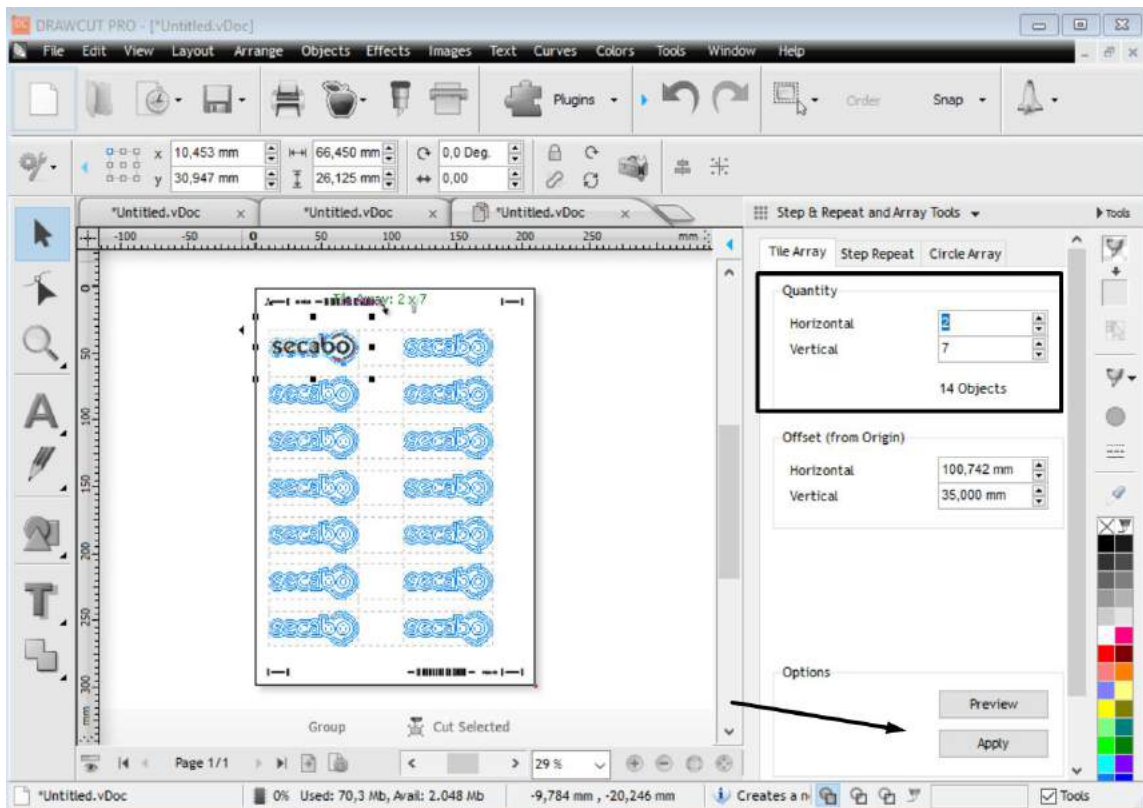

- Click “Contour Cut Wizard” again.

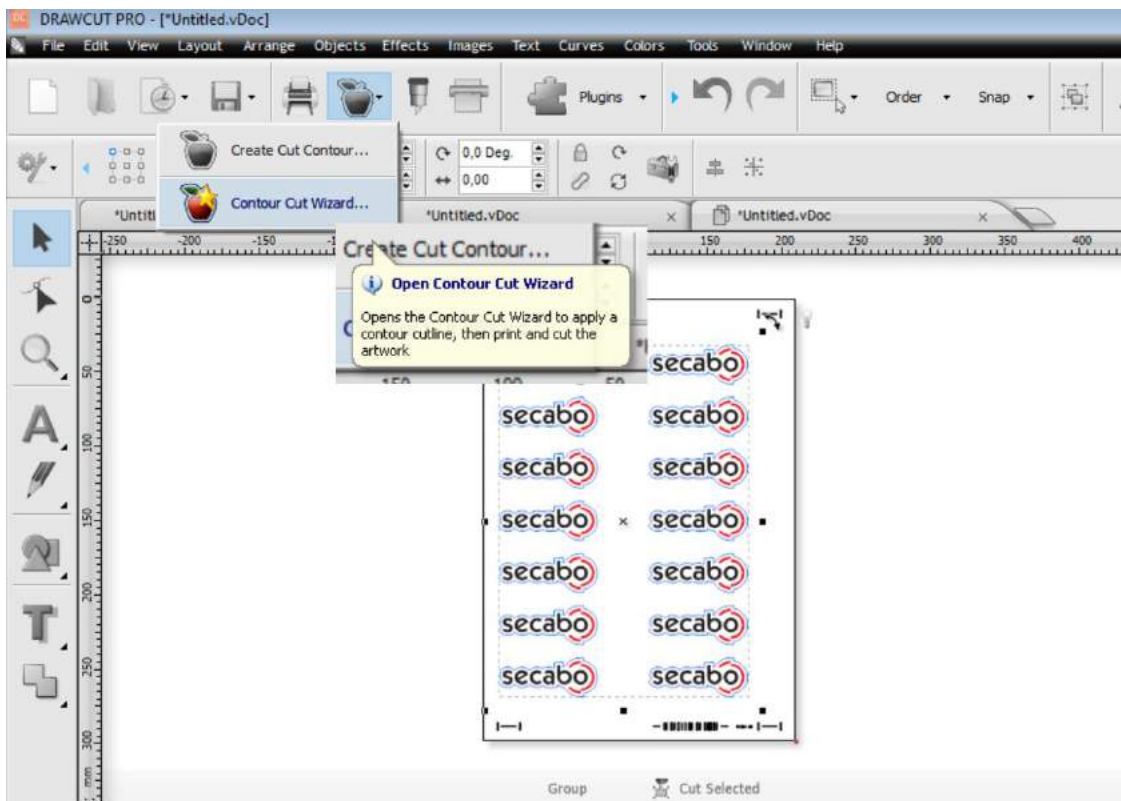



- Choose the “Printing Device”, based on how you want to create the printing artwork. You can either print directly to your printer, or save a PDF or TIFF file to be printed by some other means.

IMPORTANT:

After you have built the print artwork, which we recommend you use “Save PDF” option, so you always have a copy of the actual artwork with the correct barcode number, you must also submit the cutting data (Add CutJob).

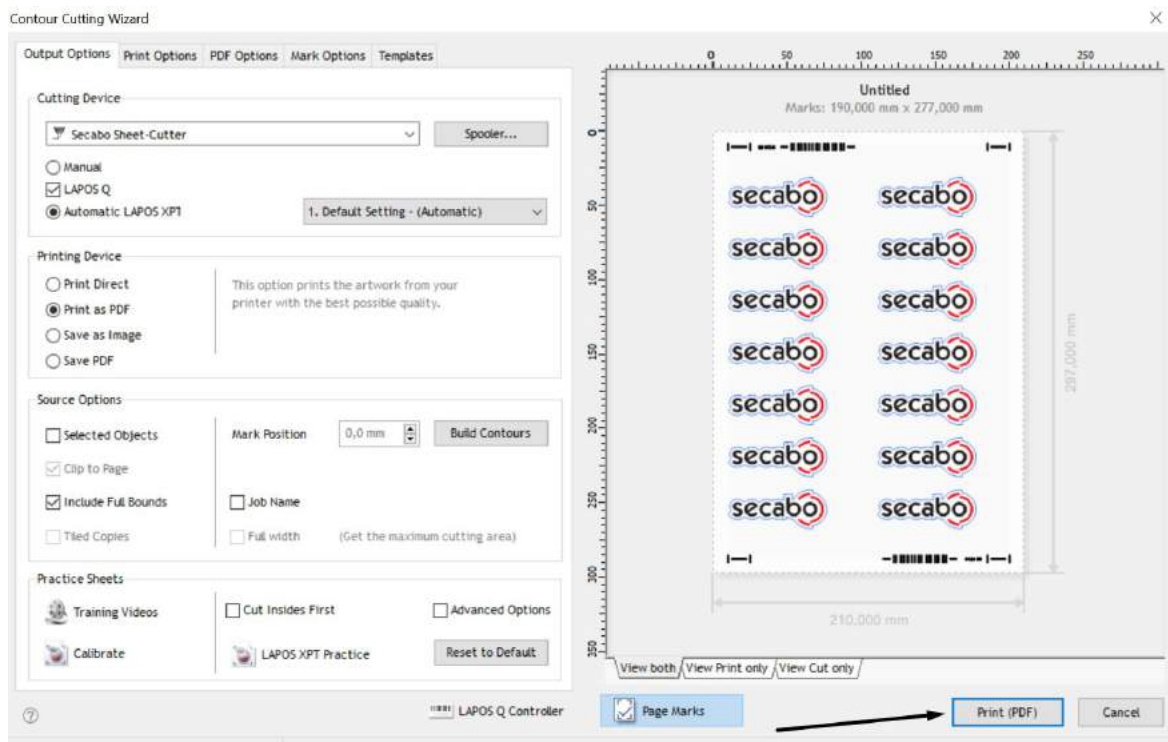

- Make sure that the print is at 100%

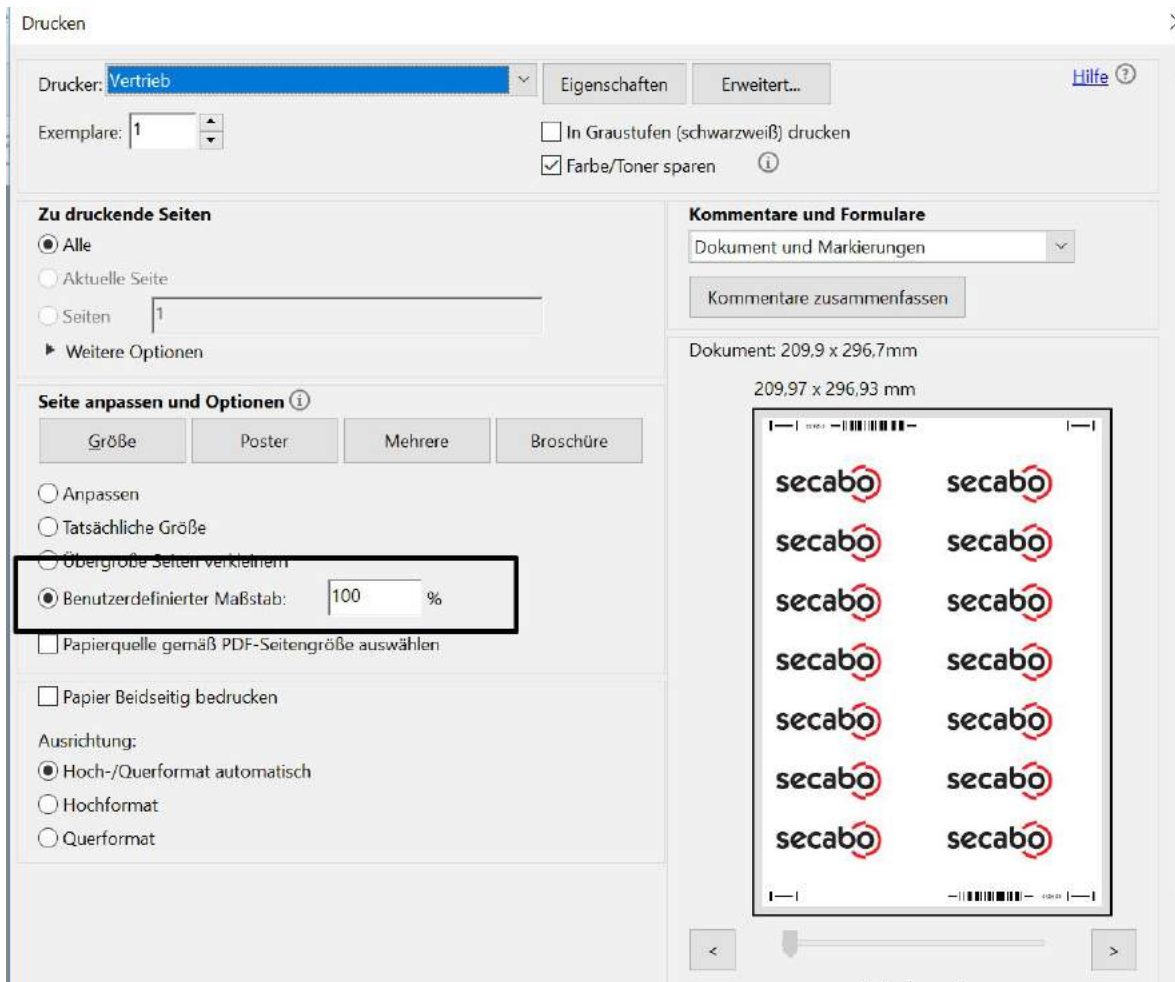

- After creating the printing PDF, click “Add Cutjob”

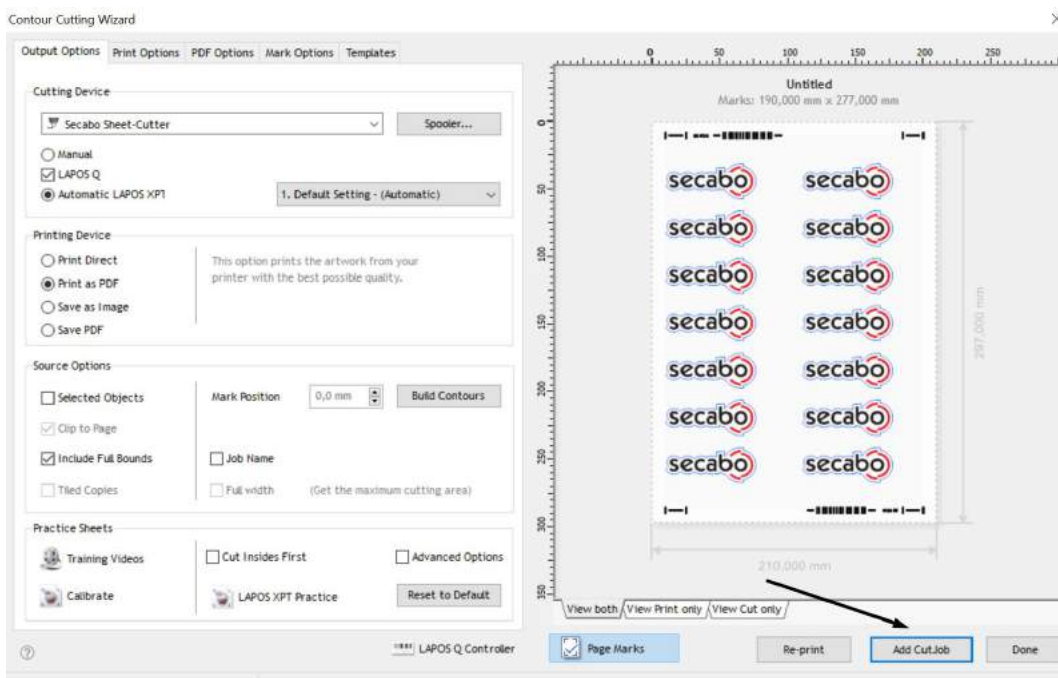

- You will see a message appear, letting you know that the cutting data has been generated for the PDF file you just created.

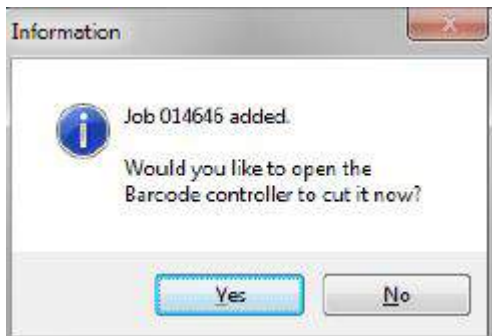

The first cut job

- Put your prints into the Paper Tray and fix those with the Paper guidance.
- Run the Spooler in Drawcut Pro

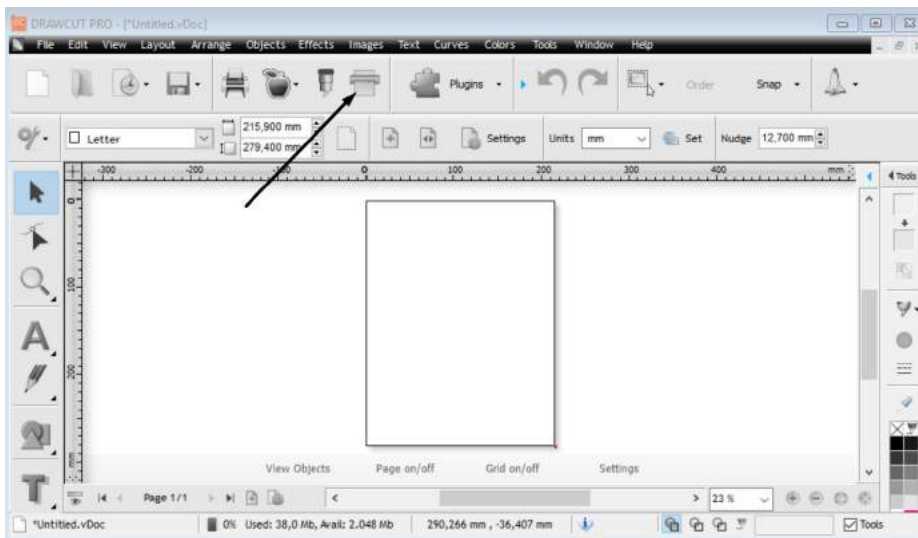

- Click on Lapos Q Controller

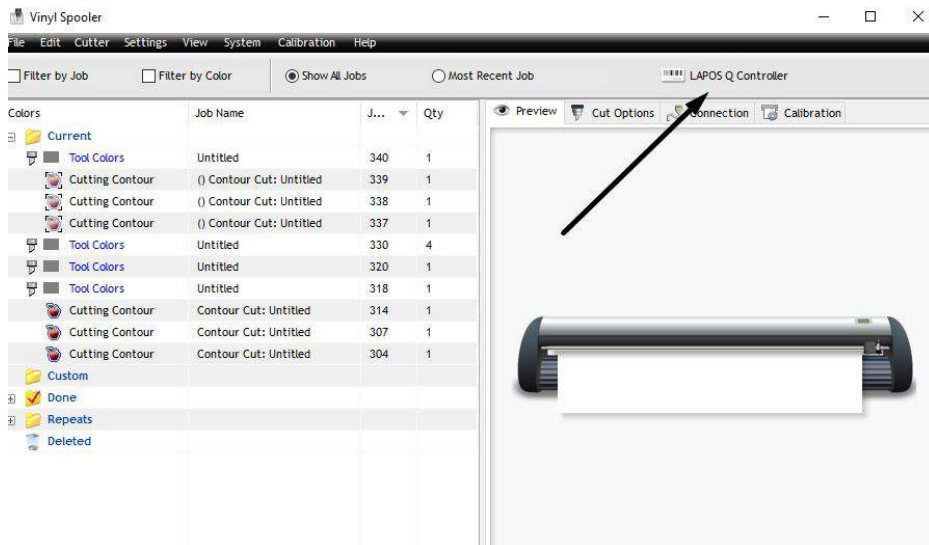

- The Lapos Q module should now be running. Go to setting

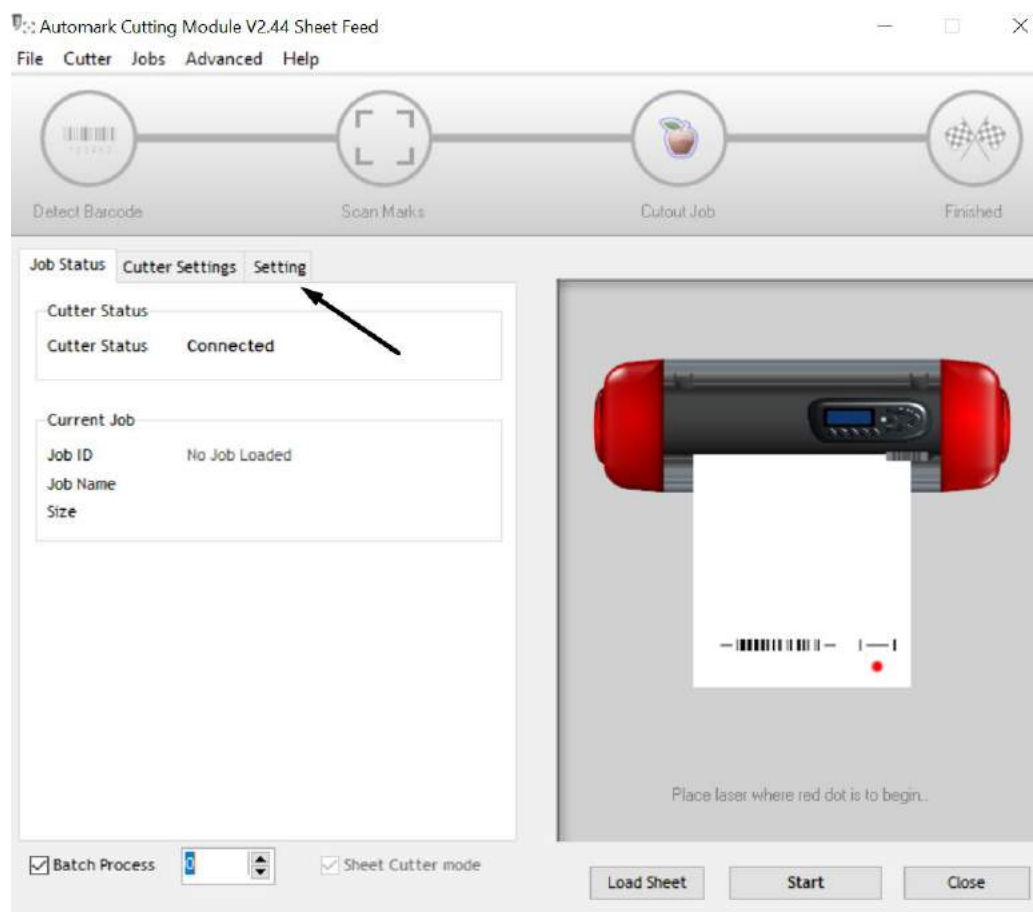

- Make sure that the settings for the paper size and the position of the marks are set similar to the job you created. **If you do not set this value correctly, the machine will not be able to load/eject the paper correctly.**

- Concerning the marks there are 2 things that cause the position of the marks to change.
 - The main reason is the positions you use when you design the artwork.
 - The other factor that could influence the printed location of the marks is the printer. Some printers may print the artwork in a slightly different position, for example, 2mm further away from the edge of the paper, etc.
- You can easily correct for both of these situations by physically measuring the actual printed position of the marks (as shown in the picture above), and entering in the measured values.
- Take special care to notice what parts of the marks need to be measured (shown by the green and red arrows above), and enter the values in the correct edit boxes (as shown by the color circles that need to match the color arrows; Notice how you need to pay special attention to the exact place to measure from)

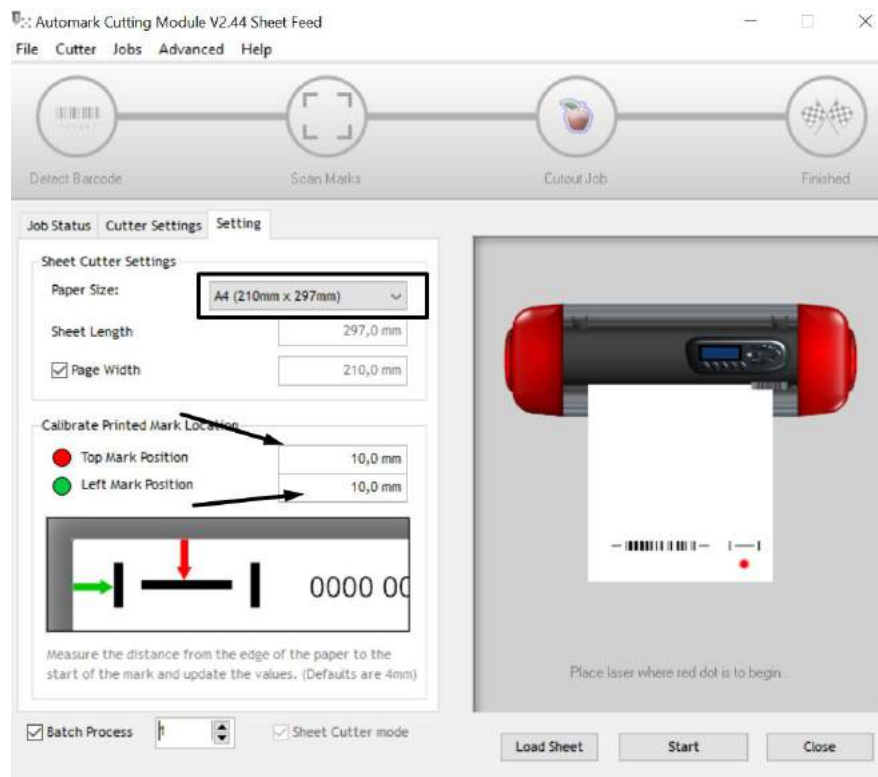

- Enable Batch Process, then click on start.

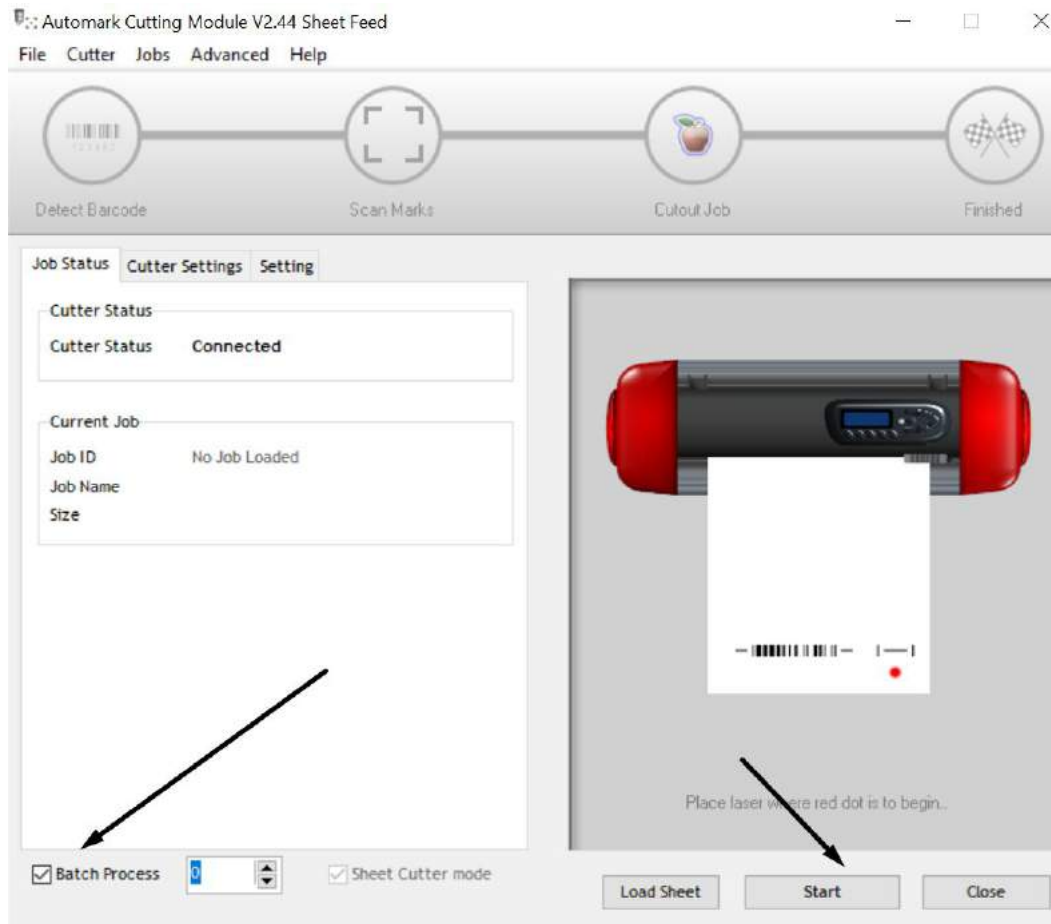

- After that the cutter will start automatically!

Initial operation of the device

Make sure that there is sufficient space for the film transport in front of and behind the device. The cutter may only be operated in a clean and dry environment.



- Connect the Sheet Cutter to a 230 V socket using the supplied power cable.
- Now switch on the cutter.

Installing and adjusting the blade

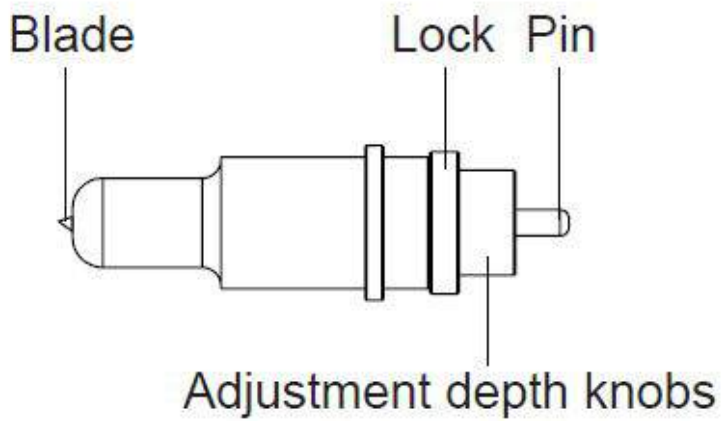
Blade Holder



Different Types of Drag Knife

	60°	0.1mm	For thick media. The sharply angled tip provides a longer cutting edge. Suitable for cutting media from 0.5 to 1.5 mm thick.
	45°	0.1mm	For adhesive stickers, instant paste
	30°	0.1mm	For Film , very soft material

Changing the blade

- Push the PIN of the blade holder, in advance you can take out the bottom

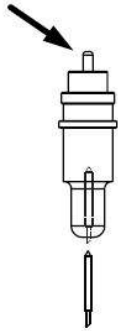

Notice

The Drag Knife is a consumable item, and you'll always get the best quality cut with a new blade.

Please replace with a new blade when:

1. The tip of blade is broken.
2. The cutting traces are not as good as they were.
3. The cutting traces are not as good as they were.

Adjusting the blade length

The blade length is adjusted by turning the blade adjustment knob.

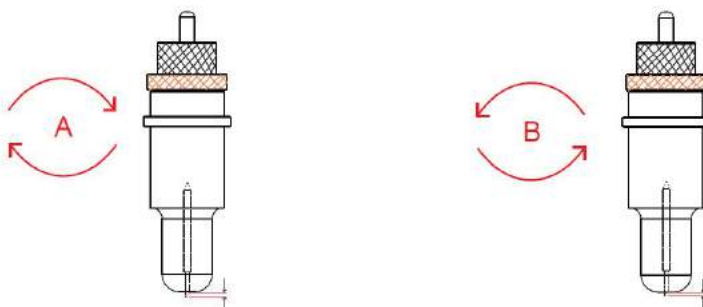

- To extend the cutter blade, turn the **knob** in the A direction.
- To retract the cutter blade, turn the **knob** in the B direction.
- Confirm the adjustment by fixing the **lock**

How to adjust the correct blade length

Gradually increase the blade length to suit the thickness of the medium being used. The ideal blade length is a length that is slightly less than the combined thickness of the film and its backing sheet, but greater than the thickness of the film itself. Adjust the blade length so that only traces of the blade appear on the backing sheet when a cutting test is performed. If the blade cuts right through the backing sheet, decrease the blade length. If the blade does not cut the film cleanly, increase the blade length.

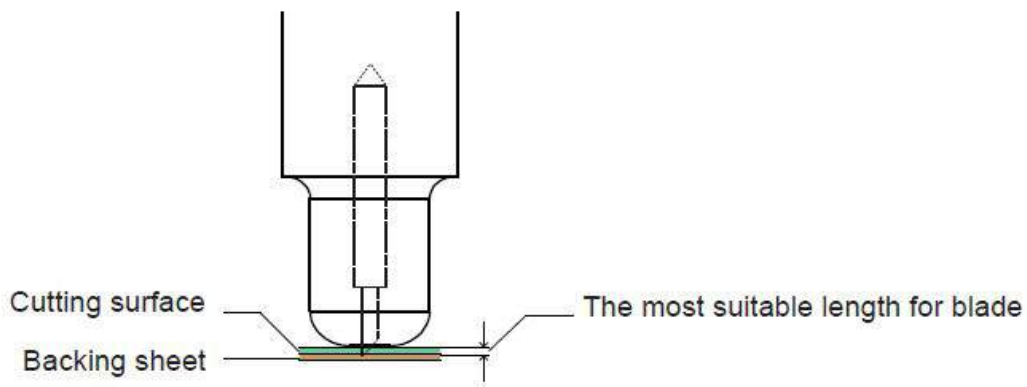

Be sure to adjust the blade length correctly. If the blade length is too long for the thickness of the medium being used, you may damage the writing panel and/or the blade itself.

Inserting the tools

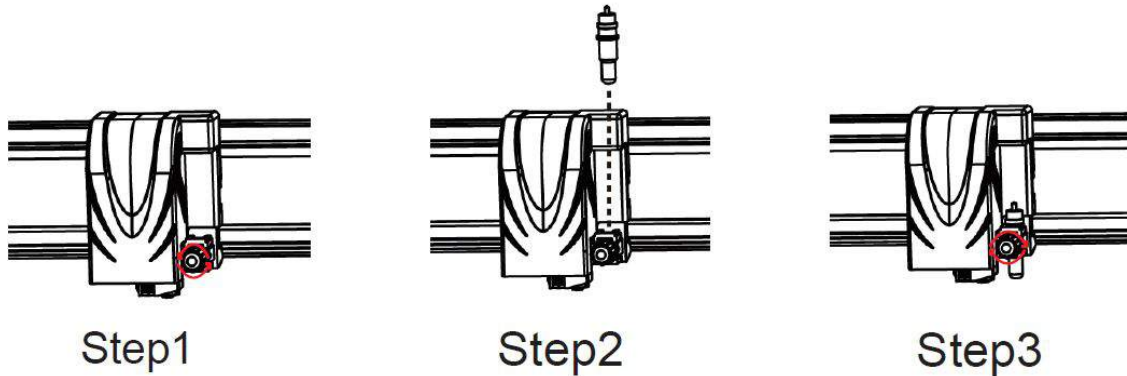

- Step1: Loosen the tool holder screw sufficiently to enable a penholder/bladeholder to be inserted up to its flange
- Step2: Push the penholder/bladeholder all the way into the holder until it contacts the upper part of the tool holder
- Step 3: Tighten the screw

Blade Offset and Overcut in Drawcut

- Both values can be set in Drawcut's Vinyl Spooler

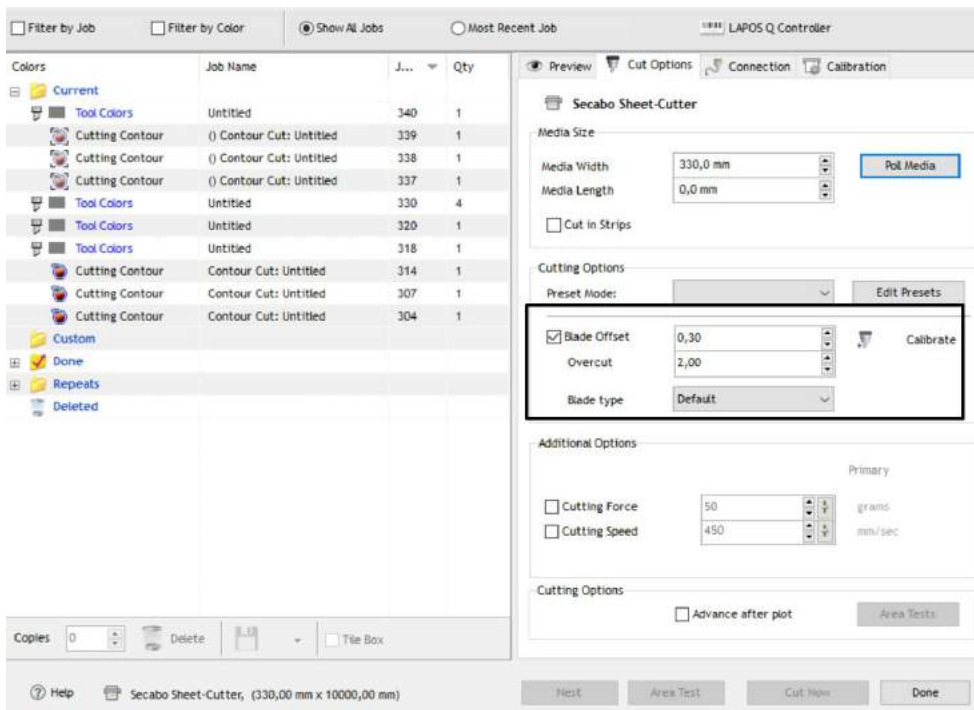

- Blade Offset

- Machine default is 0.3mm, but sometimes depending on the thickness of the material, need to test and adjust.
- If the corners of the squares are rounded, the offset setting is too low. Conversely, if the corners are too pointed, the offset setting is too high

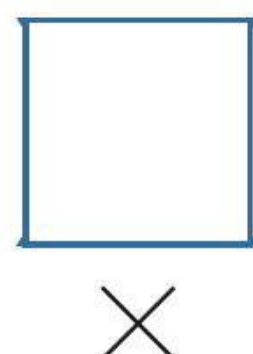
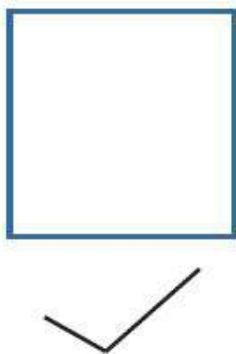

- Overcut

- Machine default is 2 mm, but sometimes depending on the thickness of the material, need to test and adjust.
- The general starting point and end point in cutting junction, need to change the parameters, mainly used for cutting thickness of ≥ 0.2 materials

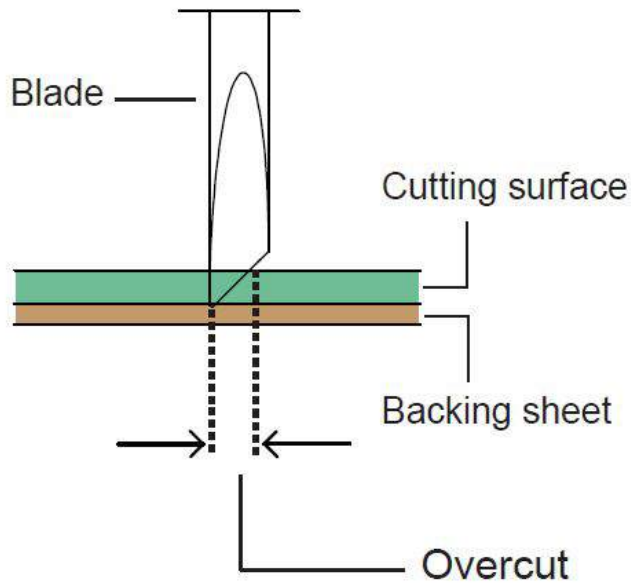

Loading the media

- Make sure that the media is flat

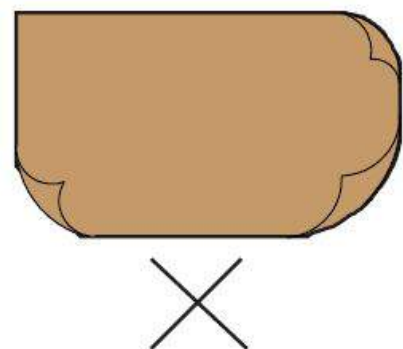
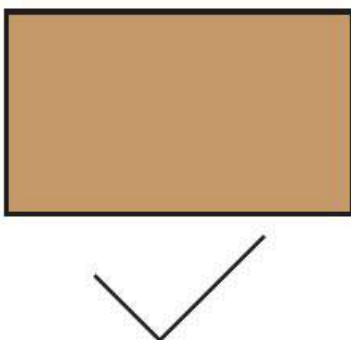

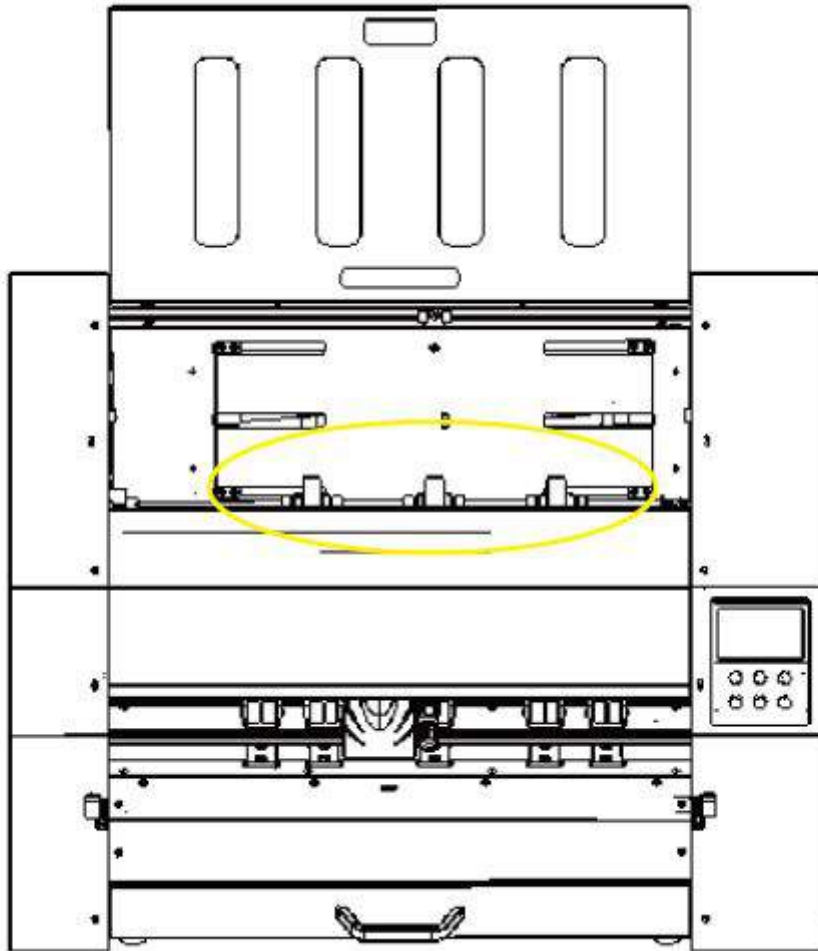

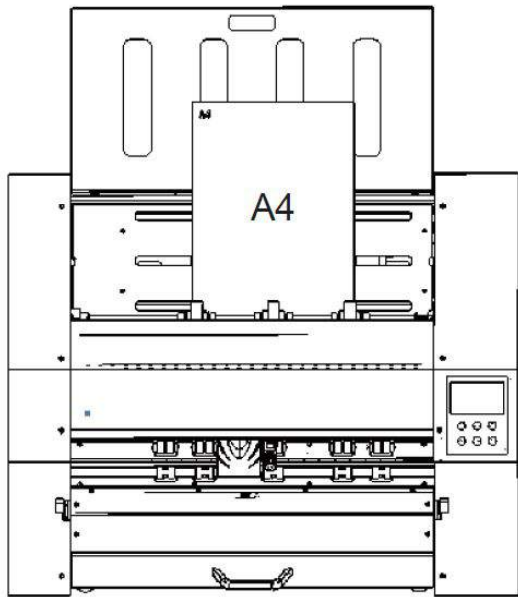

Installing A4 paper

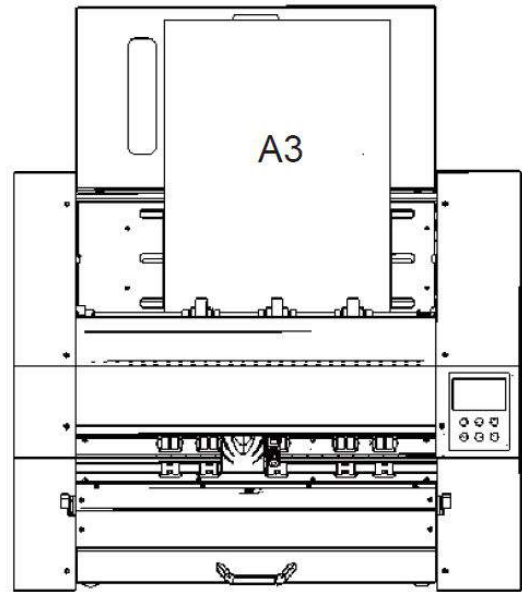

Installing A3 paper

Cutting test

- Place an A4 or an A3 sheet in front of the front bar

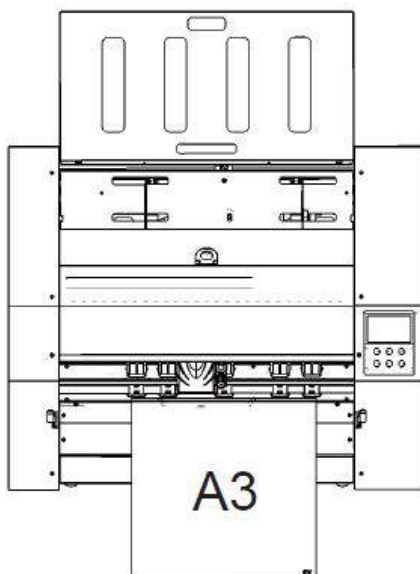

- Install a blade holder in the tool holder
- Push TEST on the Touchscreen
- Push the LOAD Button, the paper will be feeded automatically and the carriage will move on paper.
- Push the Force Test

Drag knives

Drag knives are sensitive, sharp and dangerous precision tools.

- Keep the blade out of the reach of children!
- To avoid personal injury, caution must be taken in handling the blades.

Handle the drag knives carefully and always store them with the protection cap when not in use. Should the tip of a blade come hit hard materials such as glass or stone, it can cause tiny fractures of the tip of the blade, making the blade unusable.

Please consider the following instructions to prevent unnecessary wear and tear of your drag knives and to achieve a long durability of these products instead

- In any case, avoid cuts into the carrier material of the foil. The deeper you cut into the used material, the higher will be the wear and tear of the blade.
- Adjust the cutting depth of the blade so that the material is merely cut cleanly. If the blade protrudes any further, it reduces the durability of the blade and good cutting results can no longer be guaranteed.
- For thicker materials, use knives specially suited for it (e.g. flock knife for flock).
- Frayed edges after cutting the foil indicate a blunt drag knife. Replace worn blades immediately!



Technical data

Model	SC30
Type	Sheet Cutter with servomotor and LAPOS Q sensor
Effective cutting area	330 x 488mm
Effective contour cutting area	320 x 478mm
Maximum cutting weight paper	≤ 300g
Maximum cutting depth	≤ 0,3mm
Connections	USB
Display	LCD Touchscreen
Max. speed (straight line)	960mm/s
Maximum force	750g (3g/step)
Mechanical resolution	0,015mm
Repetition accuracy	< +/-0,01mm
Power supply	AC 90V - 240V / 50Hz - 60Hz
Environment	+5°C - +35°C / 30% - 70% relative humidity
Weight without packaging	36,4kg
Weight with packaging	55,8 kg
Dimensions (W x H x D)	655 x 510 x 370mm
Packing Dimensions (W x H x D)	840 x 690 x 550mm

Konformitätserklärung - Statement of Conformity

Hiermit erklären wir in alleiniger Verantwortung, dass das unter „Technische Daten“ genannte Produkt mit den Bestimmungen der folgenden EG-Richtlinien und Normen übereinstimmt:

We herewith declare under sole responsibility that the under „technical data“ mentioned product meet the provisions of the following EC Directives and Harmonized Standards:



EG-Richtlinien / EC directives:

2014/35/EG Niederspannungsrichtlinie /

2014/35/EC Low Voltage Directive

98/37/EG Maschinenrichtlinie (2006/42/EG vom 12/29/2009) /

98/37/EC Directive on machinery (from 2009-12-29: 2006/42/EC)

Norm / Standard: EN 60204-1:2006

Technische Dokumente bei / Technical documents at:

Secabo GmbH, Hochstatt 6-8, 85283 Wolnzach, Germany

Dipl. Ing. Fabian Franke

Dipl. Ing.(FH) Bernhard Schmidt